

SURFACE MOUNT THYRISTOR***Surge Compliance***

- ◆ IEC 61000-4-5 (Surge) 400A (8/20us)
- ◆ GR1089 (Surge) 150A (10/360us)
- ◆ ITU-T K.21 (Surge) 150A (5/310us)
- ◆ TIA-968-A (Surge) 125A (10/560us)

Application

- ◆ T1/E1
- ◆ SLIC Line Interface
- ◆ ADSL/ISDN Line Interface
- ◆ Ethernet

Features

- ◆ Bi-directional Configuration
- ◆ Quick Response Time
- ◆ High Surge Capability
- ◆ Low Leakage Current

Mechanical Characteristics

- ◆ DO-214AA Package (SMB)
- ◆ Weight 100 Milligram (Approximate)
- ◆ Flammability Rating UL94V-0
- ◆ Lead Free Plating
- ◆ Reel Size 13"
- ◆ 3,000 PCS Per Reel

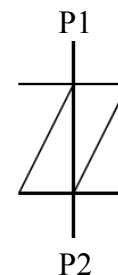
Package**DO-214AA*****Pin Configuration***

DEVICE CHARACTERISTICS

Maximum Rating			
Parameter	Symbol	Value	Units
Surge Current – 60Hz	I_{TSM}	30	A
Lead Soldering Temperature	T_L	260 (10s)	°C
Operating Temperature Range	T_J	-40~150	°C
Storage Temperature Range	T_{STG}	-55~150	°C

Electrical Characteristics (@25 °C)								
Part Number	V_{DRM} (Volt)	V_S (Volt)	I_S (mA)	I_{DRM} (μ A)	I_H (mA)	I_T (A)	V_T (V)	C_o (pF)
NLC0080SC	6	25	800	5	60	2.2	4	260
NLC0300SC	25	40	800	5	60	2.2	4	250
NLC0640SC	58	77	800	5	150	2.2	4	155
NLC0720SC	65	88	800	5	150	2.2	4	150
NLC0900SC	75	98	800	5	150	2.2	4	140
NLC1100SC	90	130	800	5	150	2.2	4	115
NLC1300SC	120	160	800	5	150	2.2	4	105
NLC1500SC	140	180	800	5	150	2.2	4	95
NLC1800SC	170	220	800	5	150	2.2	4	90
NLC2300SC	190	260	800	5	150	2.2	4	80
NLC2600SC	220	300	800	5	150	2.2	4	80
NLC3100SC	275	350	800	5	150	2.2	4	80
NLC3500SC	320	400	800	5	150	2.2	4	70

RATING CURVES

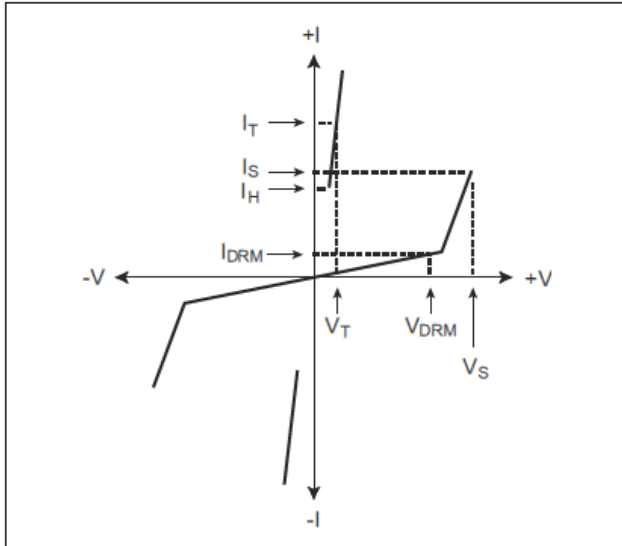

V-I Characteristics

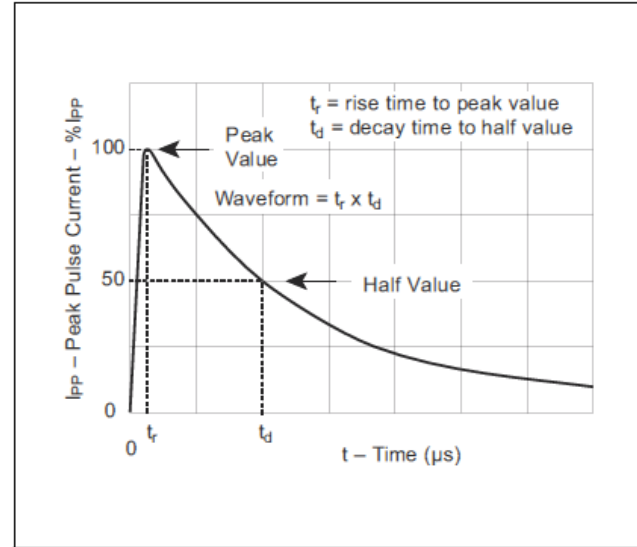

$t_r \times t_d$ Pulse Wave-form

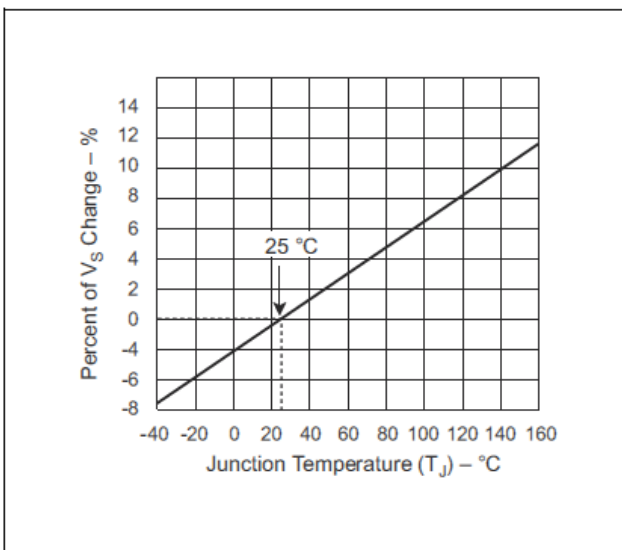

Normalized V_S Change versus Junction Temperature

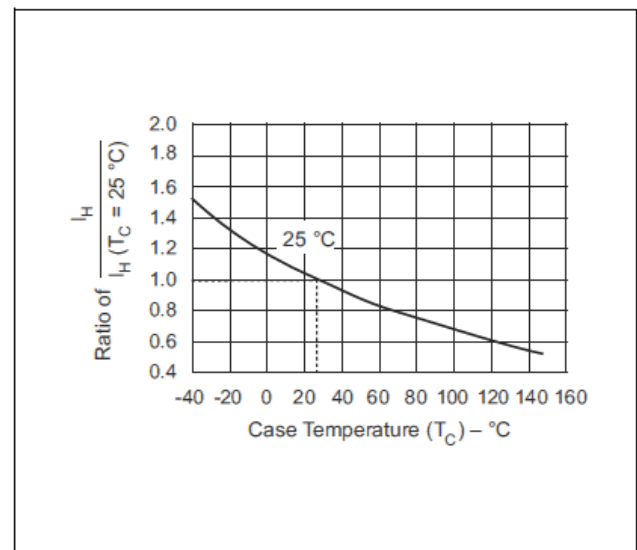

Normalized DC Holding Current versus Case Temperature

Surge Rating @ 25°C

Series	I_{PP} 2x10 μs Amps	I_{PP} 8x20 μs Amps	I_{PP} 10x160 μs Amps	I_{PP} 10x560 μs Amps	I_{PP} 10x1000 μs Amps	I_{TSM} 60 Hz Amps	di/dt Amps/ μs
SA	150	150	90	50	45	20	500
SB	250	250	150	100	80	25	500
SC	500	400	200	125	100	30	500

DIMENSIONS

Outline Dimension				
Symbol	Millimeters		Inches	
	Min	Max	Min	Max
A	1.96	2.21	0.077	0.087
B	3.30	3.94	0.130	0.155
C	4.06	4.57	0.160	0.180
D	1.95	2.50	0.079	0.098
E	0.76	1.52	0.030	0.060
F	5.21	5.59	0.205	0.220
G	0.10	0.21	0.004	0.008
H	0.15	0.31	0.006	0.012

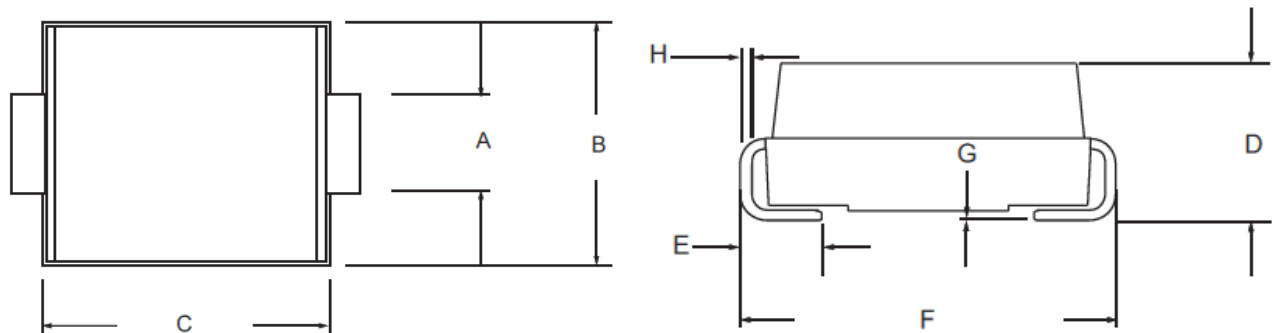

LAYOUT PAD

Layout PAD Dimension				
Symbol	Millimeters		Inches	
	Min	Max	Min	Max
A	6.00	-	0.236	-
B	2.80	-	0.110	-
C	2.00	-	0.079	-

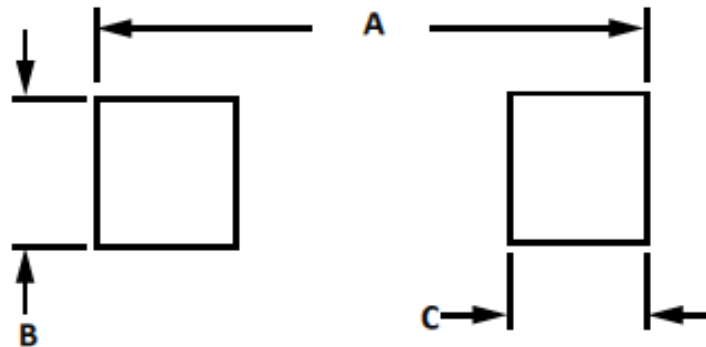

Revision History	Modification Description
Rev.1.0	Initial Release
Rev.1.01	Edit Document Layout
Rev.1.02	Make Correction on I_{TSM} and Surge Rating