

Low Capacitance Bi-directional TVS

IEC Compliance

- ◆ IEC 61000-4-2 (ESD)
8KV - Contact Discharge
15KV - Air Discharge
- ◆ IEC 61000-4-4 (EFT) 40A (5/50ns)

Application

- ◆ Ethernet Application
- ◆ Embedded System
- ◆ Handheld Device
- ◆ Computer

Features

- ◆ 150W Peak Pulse Power
- ◆ Low Clamping Voltage
- ◆ Low Leakage Current
- ◆ Single Line, Bi-Directional

Mechanical Characteristics

- ◆ SOD-323 Package
- ◆ Weight 5 Milligram (Approximate)
- ◆ Flammability Rating UL94V-0
- ◆ Lead Free Plating
- ◆ Reel Size 7"
- ◆ 3,000 PCS Per Reel

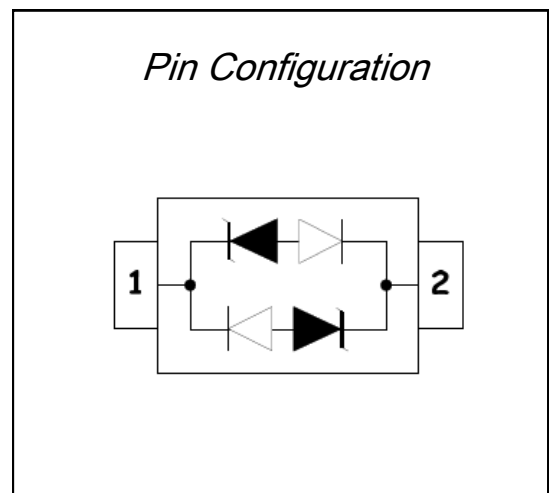
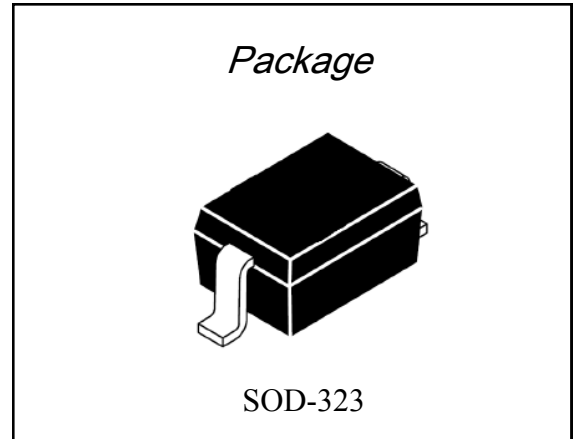

DEVICE CHARACTERISTICS

Maximum Rating			
Parameter	Symbol	Value	Units
Peak Pulse Power (tp=8/20us waveform)	P _{PP}	150	Watt
Lead Soldering Temperature	T _L	260 (10s)	°C
Operating Temperature Range	T _J	-55~150	°C
Storage Temperature Range	T _{STG}	-55~150	°C

Electrical Characteristics (@25 °C)							
Part Number	Device Marking	V _{RWM} (Volt)	V _B (Volt)	V _C (Volt)	I _{PP} (A)	I _R (uA)	C _J (pF)
NLC3311CCW	CA1	3	3.5	15	10	0.5	1

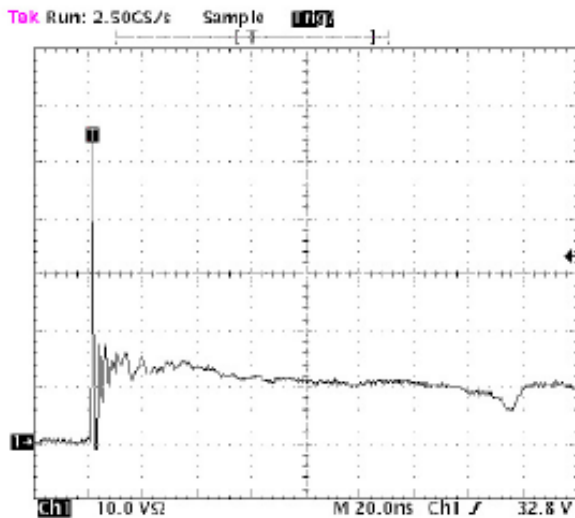

Figure1. Clamping waveform of positive 8KV ESD contact

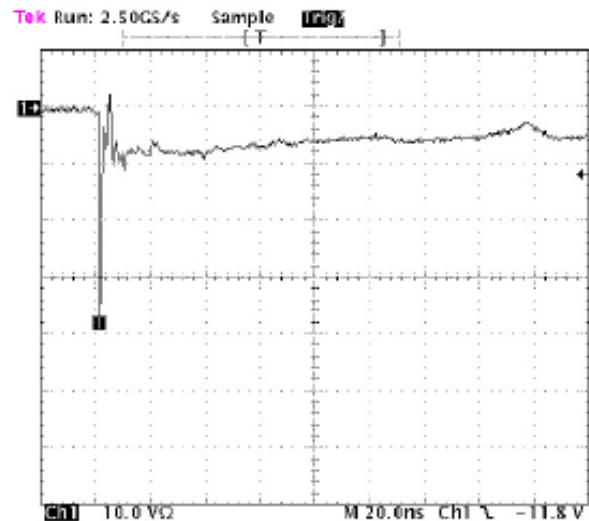
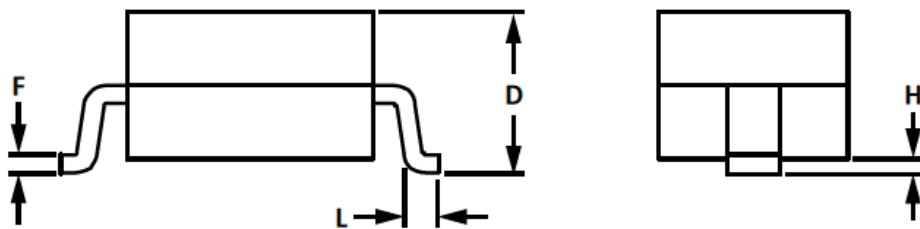
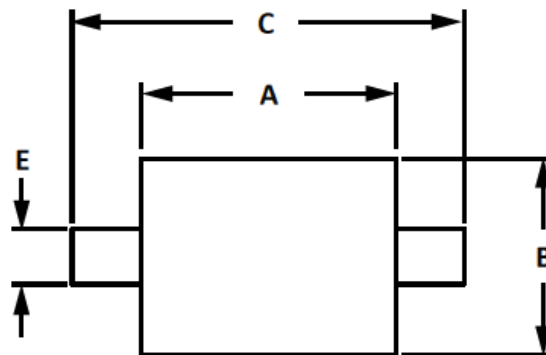

Figure2. Clamping waveform of negative 8KV ESD contact

DEVICE OUTLINE

Outline Dimension				
Symbol	Millimeters		Inches	
	Min	Max	Min	Max
A	1.60	1.80	0.062	0.070
B	1.15	1.35	0.045	0.053
C	2.30	2.70	0.090	0.105
D	0.80	1.15	0.031	0.045
E	0.25	0.40	0.010	0.016
F	0.089	0.177	0.003	0.007
H	0.00	0.10	0.000	0.004
L	0.08TYP		0.003TYP	



LAYOUT PAD DIMENSION

Layout PAD Dimension				
Symbol	Millimeters		Inches	
	Min	Max	Min	Max
A	2.75	2.95	0.108	0.116
B	0.53	0.73	0.021	0.029
C	0.73	0.93	0.029	0.037

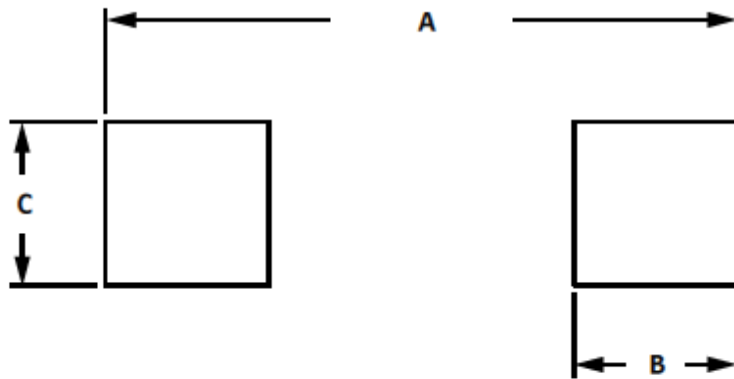

Revision History	Modification Description
Rev.1.0	Initial Release
Rev.1.01	Edit Document Layout